

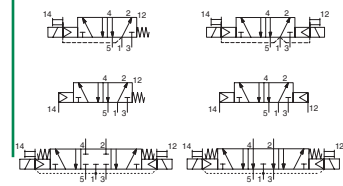

SPOOL VALVES

pilot operated or air operated, spool type
single/dual solenoid or air
aluminium body, 1/4 to 1/2



5/2-5/3
Series
551
552
553

FEATURES

- All the exhaust ports of the spool valve are connectable, providing better environmental protection. Particularly recommended for sensitive areas, such as clean rooms, and applications in the pharmaceutical and food processing sectors
- The valves offer environmental protection against the ingress of liquids, dusts or other foreign matter (environmentally-protected construction)
- The monostable spool valves in conformity with IEC 61508 Standard (2010 route 2_H version) have TÜV (551 series) and EXIDA (551-552-553 series) certified with integrity levels: SIL 2 for HFT = 0 / SIL 3 for HFT = 1
- The solenoid valves satisfy all relevant EC directives

GENERAL

Differential pressure
Flow (Qv at 6 bar)

2 - 10 bar [1 bar = 100 kPa]
l/min (ANR)

1/4	3/8	1/2
860	3000	3800

fluids (*)	temperature range (TS)	seal materials (*)
air, inert gas, filtered	-25°C to +60°C	NBR (nitrile) + PUR (polyurethane)

MATERIALS IN CONTACT WITH FLUID

(*) Ensure that the compatibility of the fluids in contact with the materials is verified

Body, end cover	Aluminium, black anodized
End cover (spring return)	Glass fibre filled PA
Spool valve internal parts	Zamak, stainless steel, POM, aluminium
Seals	NBR + PUR
Core and core tube	Stainless steel
Shading coil	Copper

ELECTRICAL CHARACTERISTICS

Coil insulation class	F
Connector	Spade plug (cable Ø 6-8 mm or Ø 6-10 mm)
Connector specification	DIN 43650, 11 mm, industry standard B (type 01) or ISO 4400 / EN 175301-803, form A (type 02)
Electrical safety	IEC 335
Electrical enclosure protection	Moulded IP65 (EN 60529)
Standard voltages	DC (=): 24V - 48V AC (~): 24V - 48V - 115V - 230V / 50 Hz

prefix option	power ratings				operator ambient temperature range (TS) (C°)	replacement coil		type ⁽¹⁾
	inrush ~ (VA)	holding ~ (VA) (W)		hot/cold = (W)		~ 230 V/50 Hz	= 24 V DC	
		(VA)	(W)					
SC	6	3,5	2,5	2,5/3	-25 to +60	400127-097	400904-542	01
SC	15	7	5	5/6,9	-25 to +60	400727-117	400727-185	02

⁽¹⁾ Refer to the dimensional drawings on the following page

SPECIFICATIONS

pipe size	orifice size (mm)	flow coefficient Kv (m ³ /h) (l/min)		operating pressure differential (bar)			power coil (W)		catalogue number	options		
				min.	max. (PS)		~	=		maintained	man. operator	
					air (*)	~						
G	(mm)	(m ³ /h)	(l/min)	~	=	~	=	~/=				
5/2 - Solenoid air pilot operated - spring return (monostable)												
1/4	6	0,75	12,5	2	10	10	2,5	3	SCG551A017	MS	-	-
3/8	12	2,49	41,5	2	10	10	5	6,9	SCG552A017	MS	-	-
1/2	13	3,15	52,5	2	10	10	5	6,9	SCG553A017	MS	-	-
5/2 - Solenoid air pilot operated and return (bistable)												
1/4	6	0,75	12,5	2	10	10	2,5	3	SCG551A018	MS	-	-
3/8	12	2,49	41,5	2	10	10	5	6,9	SCG552A018	MS	-	-
1/2	13	3,15	52,5	2	10	10	5	6,9	SCG553A018	MS	-	-
5/3 - W1 - pressure held, solenoid air pilot and return												
1/4	6	0,75	12,5	2	10	10	2,5	3	SCG551A067	MS	-	-
3/8	12	2,49	41,5	2	10	10	5	6,9	SCG552A067	MS	-	-
1/2	13	3,15	52,5	2	10	10	5	6,9	SCG553A067	MS	-	-
5/3 - W3 - pressure released, solenoid air pilot and return												
1/4	6	0,75	12,5	2	10	10	2,5	3	SCG551A068	MS	-	-
3/8	12	2,49	41,5	2	10	10	5	6,9	SCG552A068	MS	-	-
1/2	13	3,15	52,5	2	10	10	5	6,9	SCG553A068	MS	-	-
5/2 - Solenoid air pilot operated spring return (monostable), certified IEC 61508 Functional Safety data												
1/4	6	0,75	12,5	2	10	10	2,5	3	SCG551A017SL	-	-	-
3/8	12	2,49	41,5	2	10	10	5	6,9	SCG552A017SL	-	-	-
1/2	13	3,15	52,5	2	10	10	5	6,9	SCG553A017SL	-	-	-

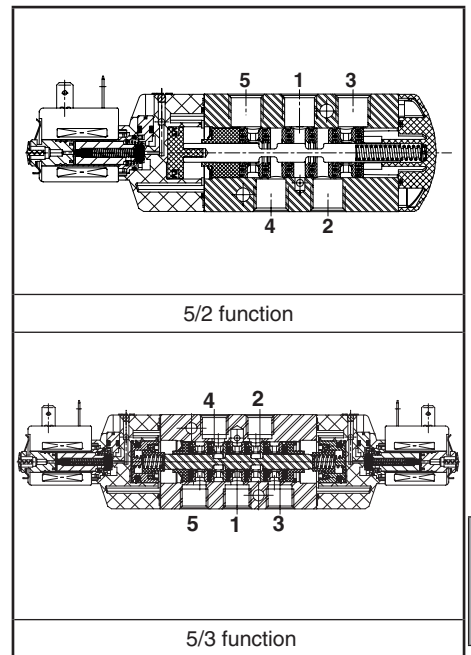

G

AIR OPERATED AND OPTIONS

- Versions (Type 03): - pilot air operated, spring return, catalogue numbers: **G551A117 / G551A117SL** (1/4); **G552A117 / G552A117SL** (3/8); **G553A117 / G553A117SL** (1/2)
- pilot air operated and return, catalogue numbers: **G551A118** (1/4); **G552A118** (3/8); **G553A118** (1/2)
- Suffix "MF" (air operated only, low temperature version, -40°C)
- Suffix "GD" (air operated only, ATEX 2GD c)
- Compliance with "UL" standard is available on request
- Explosionproof enclosures for use in zones 1/21-2/22, categories 2-3 to ATEX Directive 94/9/EC (see "Explosionproof solenoids" section)
- Supply rail
- Other pipe connections are available on request
- Plug with visual indication and peak voltage suppression or with cable length of 2 m (see Solenoids, Coils & Accessories section)

INSTALLATION

- The valves can be mounted in any position without affecting operation
- It is necessary to connect pipes or fittings to the exhaust ports to protect the internal parts of the spool valve and its pneumatic operator if used outside or in harsh environments (dusts, liquids etc.)
- IEC 61508 Functional Safety (suffix SL). Check temperature range of valve body and solenoid for suitability. For probability of failure, contact us
- Valves with suffix "SL" are supplied with specific exhaust protectors
- Threaded pipe connection is standard: G = G (ISO 228/1)
- Installation/maintenance instructions are included with each valve

ACCESSORIES

series	pipe size	exhaust protector (stainless steel)
551	G 1/4	34600419 ⁽¹⁾
552	G 3/8	34600478 ⁽¹⁾
553	G 1/2	34600479 ⁽¹⁾
551-552-553	M5	34600484 ⁽¹⁾

ORDERING EXAMPLES:

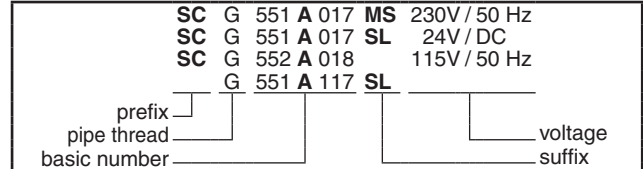

⁽¹⁾ Supplied with suffix "SL"

DIMENSIONS (mm), WEIGHT (kg)



TYPE 01

Prefix "SC" Solenoid
Epoxy moulded
IEC 335 / DIN 43650
IP65

551A017 / A017MS / A017SL / A018 / A018MS
551A067 / A067MS / A068 / A068MS



TYPE 02

Prefix "SC" Solenoid
Epoxy moulded
IEC 335 / ISO 4400
IP65

552A017 / A017MS / A018 / A018MS / A067 / A067MS / A068 / A068MS
553A017 / A017MS / A018 / A018MS / A067 / A067MS / A068 / A068MS
552A017SL / 553A017SL

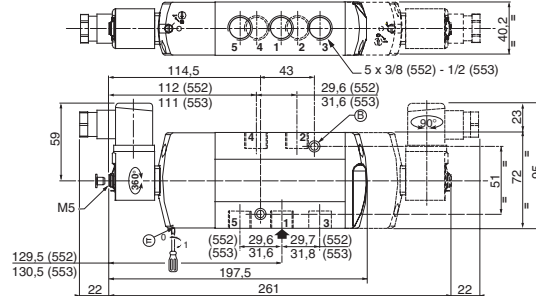
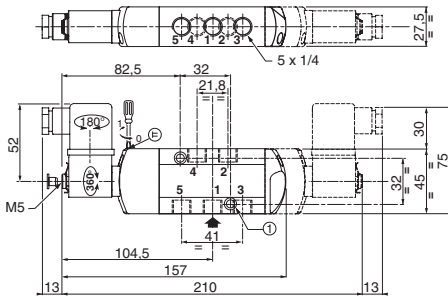

TYPE 03

No prefix
Air operated version

551A117 / A117SL / A118

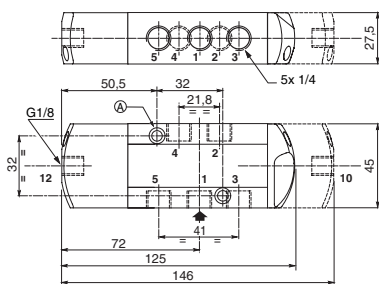

552A117 / A117SL / A118
553A117 / A117SL / A118

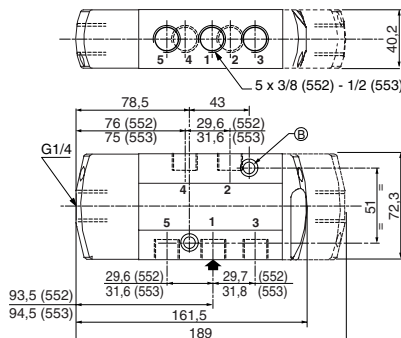

2 mounting holes:

- Ⓐ 5,3 mm dia. (Spotfacing: 9 mm dia., depth 5 mm)
- Ⓑ 6,5 mm dia. (Spotfacing: 11 mm dia., depth 6 mm)

type	prefix option	weight ⁽²⁾		
		monostable.	bistable	W1-W3
01 (551)	SC	0,48	0,60	0,60
02 (552)	SC	0,85	1,15	1,15
02 (553)	SC	0,84	1,14	1,14
03 (551)	-	0,32	0,40	0,40
03 (552)	-	0,80	1,25	1,25
03 (553)	-	0,79	1,24	1,24

⁽²⁾ Incl. coil(s) and connector(s).



SOLENOID VALVES

pilot operated, spool type
single/dual solenoid (mono/bistable function)
aluminium body, 1/4 to 1/2

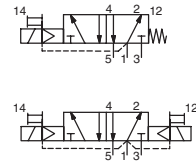

5/2
Series
551
552
553

FEATURES

- All the exhaust ports of the spool valve are connectable, providing better environmental protection. Particularly recommended for sensitive areas, such as clean rooms, and applications in the pharmaceutical and food processing sectors
- The valves offer environmental protection against the ingress of liquids, dusts or other foreign matter (environmentally-protected construction)
- Solenoid pilot valve with spade-plug connector type EN 175301-803, industry standard form C, with 9,4 mm spacing. Versions with M12 connection
- Solenoid pilot valve, CNOMO size 15 interface, with or without integral LED and electrical protection. LED indicator visible from 3 sides
- The monostable spool valves in conformity with IEC 61508 Standard (2010 route 2, version) have TÜV (551 series) and EXIDA (551-552-553 series) certified with integrity levels: SIL 2 for HFT = 0 / SIL 3 for HFT = 1
- The solenoid valves satisfy all relevant EC directives

GENERAL

Differential pressure
Flow (Qv at 6 bar)

2 - 10 bar [1 bar = 100 kPa]
l/min (ANR)

1/4	3/8	1/2
860	3000	3800

Pilot mounting interface surface

ISO 15218 (CNOMO E06.36.120N, size 15)

fluids (*)	temperature range (TS)	seal materials (*)
air, inert gas, filtered	-25°C to +40°C	NBR (nitrile) + PUR (polyurethane)

MATERIALS IN CONTACT WITH FLUID

(*) Ensure that the compatibility of the fluids in contact with the materials is verified

Body	Aluminium, black anodized
End cover (spring)	Glass fibre filled PA
Spool valve internal parts	Zamak, stainless steel, POM, aluminium
Pilot body	PARA
Pilot internal parts	POM, PET, stainless steel and brass
Pneumatic interface seal	TPE

ELECTRICAL CHARACTERISTICS

Coil insulation class	F
Connector (type 05)	Spade plug (cable Ø 4-6 mm)
Connector specification	Type 05: DIN 43650, 9,4 mm, form C
Connection	Type 07: M12 (CNOMO E03.62.520.N)
Electrical safety	IEC 335
Electrical enclosure protection	Moulded IP65 [05] or IP67 [07] (EN 60529)
Standard voltages	DC (-): 24V
(Other voltages and 60 Hz on request)	AC (~): 24V-115V-230V / 50 Hz (prefix CFSC)

prefix option	power ratings				operator ambient temperature range (TS) (C°)	voltage		type ⁽¹⁾
	inrush ~ (VA)	holding ~ (VA) (W)		hot/cold = (W)		~ (V)	= (V)	
		1,6 ⁽²⁾	1,5 ⁽²⁾					
CFSC	1,4	1,2	1,1	1/1,2	-25 to +60	24-115	24	05
	1,8 ⁽²⁾	1,6 ⁽²⁾	1,5 ⁽²⁾	1,15/1,35 ⁽²⁾				
	2,1	1,6	1,5	-		230	-	
	2,5 ⁽²⁾	2 ⁽²⁾	1,9 ⁽²⁾	-				
CFVT ⁽³⁾	-	-	-	1,15/1,35	-25 to +60	-	24	07

⁽¹⁾ Refer to the dimensional drawings on the following page.
⁽²⁾ Values with LED indicator and protection, use TPL 20674.

⁽³⁾ Supplied with LED indicator and protection.

SPECIFICATIONS

pipe size	orifice size (mm)	flow coefficient Kv (m³/h) (l/min)		operating pressure differential (bar)			power coil (W)		catalogue number		options		
				min.	max. (PS)				connector EN 175301-803 (9,4 mm) (type 05)	M12 (type 07)	maintained man. operator	impulse man. operator	
					~	=							
5/2 - Solenoid air pilot operated - spring return (monostable)													
1/4	6	0,75	12,5	2	10	10	1,1..1,5	1,2	CFSCG551C517	-	MS	MO	-
							-	1,35	-	CFVTG551C517	MS	MO	-
3/8	12	2,49	41,5	2	10	10	1,1..1,5	1,2	CFSCG552A517	-	MS	MO	-
							-	1,35	-	CFVTG552A517	MS	MO	-
1/2	13	3,15	52,5	2	10	10	1,1..1,5	1,2	CFSCG553A517	-	MS	MO	-
							-	1,35	-	CFVTG553A517	MS	MO	-
5/2 - Solenoid air pilot operated and return (bistable)													
1/4	6	0,75	12,5	2	10	10	1,1..1,5	1,2	CFSCG551C518	-	MS	MO	-
							-	1,35	-	CFVTG551C518	MS	MO	-
3/8	12	2,49	41,5	2	10	10	1,1..1,5	1,2	CFSCG552A518	-	MS	MO	-
							-	1,35	-	CFVTG552A518	MS	MO	-
1/2	13	3,15	52,5	2	10	10	1,1..1,5	1,2	CFSCG553A518	-	MS	MO	-
							-	1,35	-	CFVTG553A518	MS	MO	-

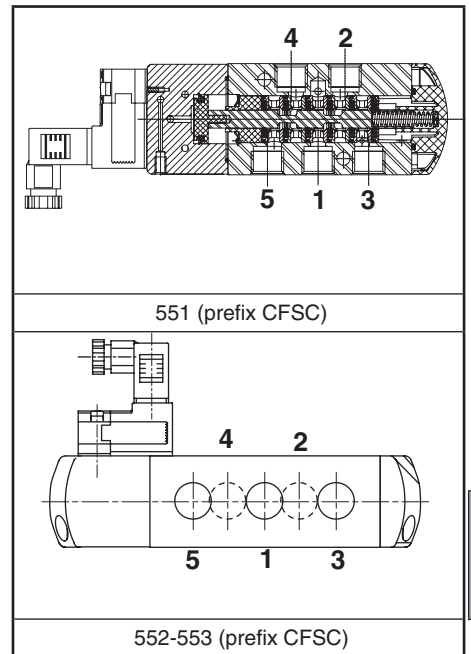

G

SPECIFICATIONS

pipe size	orifice size	flow coefficient Kv		operating pressure differential (bar)				power coil (W)		catalogue number		options	
				min.	max. (PS)		connector EN 175301-803 (9,4 mm) (type 05)			M12 (type 07)	maintained man. operator	impulse man. operator	
					air (*)	~							=
G	(mm)	(m³/h)	(l/min)										
5/2 - Solenoid air pilot operated - spring return (monostable), certified IEC 61508 Functional Safety data													
1/4	6	0,75	12,5	2	10	10	1,1...1,5	1,2	CFSCG551C517SL	-	-	MO	-
							-	1,35	-	CFVTG551C517SL	-	MO	-
3/8	12	2,49	41,5	2	10	10	1,1...1,5	1,2	CFSCG552A517SL	-	-	MO	-
							-	1,35	-	CFVTG552A517SL	-	MO	-
1/2	13	3,15	52,5	2	10	10	1,1...1,5	1,2	CFSCG553A517SL	-	-	MO	-
							-	1,35	-	CFVTG553A517SL	-	MO	-

OPTIONS

- Explosionproof enclosures for use in zones 1/21-2/22, categories 2-3 to ATEX Directive 94/9/EC (see "Explosionproof solenoids" section)
- LED and protection, prefix CFSC, use TPL number: TPL 20674 (e.g.: TPL 20674 (e.g.: CFSCXG551C505TPL20674)
- Straight M12 connector: with 5 m cable length (catalogue number **88130212**)
- Supply rail
- Versions with spade-plug connector type ISO 15217/DIN 43650 form C with 8 mm spacing or with cable ends: contact us
- Other pipe connections are available on request
- Plug with visual indication and peak voltage suppression or with cable length of 2 m (see Solenoids, Coils & Accessories section)

INSTALLATION

- The valves can be mounted in any position without affecting operation
- It is necessary to connect pipes or fittings to the exhaust ports to protect the internal parts of the spool valve and its pneumatic operator if used outside or in harsh environments (dusts, liquids etc.)
- IEC 61508 Functional Safety (suffix SL). Check temperature range of valve body and solenoid for suitability. For probability of failure, contact us
- Threaded pipe connection is standard: G = G (ISO 228/1)
- Valves with suffix "SL" are supplied with specific exhaust protectors
- Installation/maintenance instructions are included with each valve

ACCESSORIES

series	pipe size	exhaust protector (stainless steel)
551	G 1/4	34600419 ⁽¹⁾
552	G 3/8	34600478 ⁽¹⁾
553	G 1/2	34600479 ⁽¹⁾
551-552-553	M5	34600484 ⁽¹⁾

⁽¹⁾ Supplied with suffix "SL"

DIMENSIONS (mm), WEIGHT (kg)

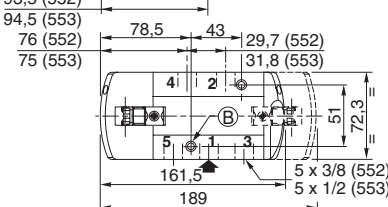
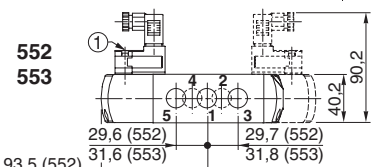
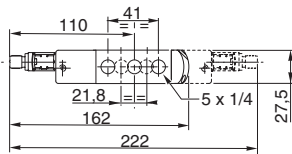
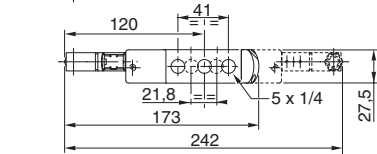
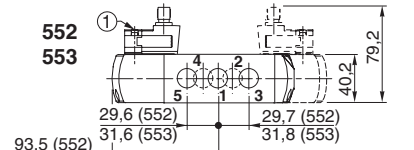
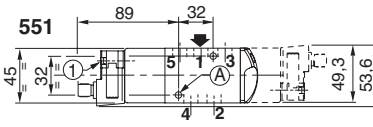
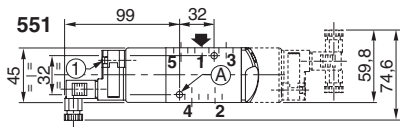
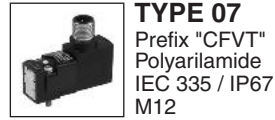
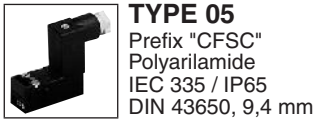

type	prefix option	weight ⁽²⁾					
		monostable			bistable		
05	CFSC	0,36	1,1	1	0,41	2,18	2,08
07	CFVT	0,38	1,12	1,02	0,45	2,22	2,12

⁽²⁾ Prefix CFSC: including connector(s).

① Manual operator location

2 mounting holes:

Ⓐ 5,3 mm dia. (Spotfacing: 9 mm dia., depth 5 mm)

Ⓑ 6,5 mm dia. (Spotfacing: 11 mm dia., depth 6 mm)