

# Precision pressure regulator, Series NL4-RGP-...-DS

- G 1/2
- Qn = 5600 l/min
- Precision pressure regulator
- Activation Mechanical
- with continuous pressure supply
- suitable for ATEX

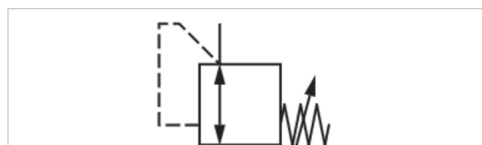

## Parts

Mounting orientation

Certificates

Working pressure min./max.

Ambient temperature min./max.

Medium temperature min./max.

Medium

Regulator type

Regulator function

Adjustment range min./max.

Pressure supply

Activation

Internal air consumption q max.

Weight

Precision pressure regulator with continuous pressure supply

Any

suitable for ATEX

0,5 ... 16 bar

-10 ... 60 °C

-10 ... 60 °C

Compressed air Neutral gases

Diaphragm-type pressure regulator Can be assembled into blocks

with relieving air exhaust

See table

double

Mechanical

2,6 l/min

0,867 kg

## Technical data

Part No.	Port	Flow	Adjustment range min./max.	Max. pressure gauge Ø in blocked state
		Qn		
0821302524	G 1/2	5600 l/min	0,1 ... 3 bar	40 mm
0821302525	G 1/2	5600 l/min	0,2 ... 6 bar	40 mm
0821302526	G 1/2	5600 l/min	0,5 ... 10 bar	40 mm

## Technical information

The pressure dew point must be at least 15 °C under ambient and medium temperature and may not exceed 3 °C .

The rear pressure gauge connection on the pressure regulator is closed with a blanking plug, the front connection is open. Depending on the customer application, a second blanking plug may be necessary. Please order separately (see accessories).

Suitable for use in Ex zones 1, 2, 21, 22

Recommended pre-filtering 5 µm

## Technical information

Material	
Housing	Die cast zinc
Front plate	Acrylonitrile butadiene styrene
Seals	Acrylonitrile butadiene rubber

## Dimensions

### Dimensions

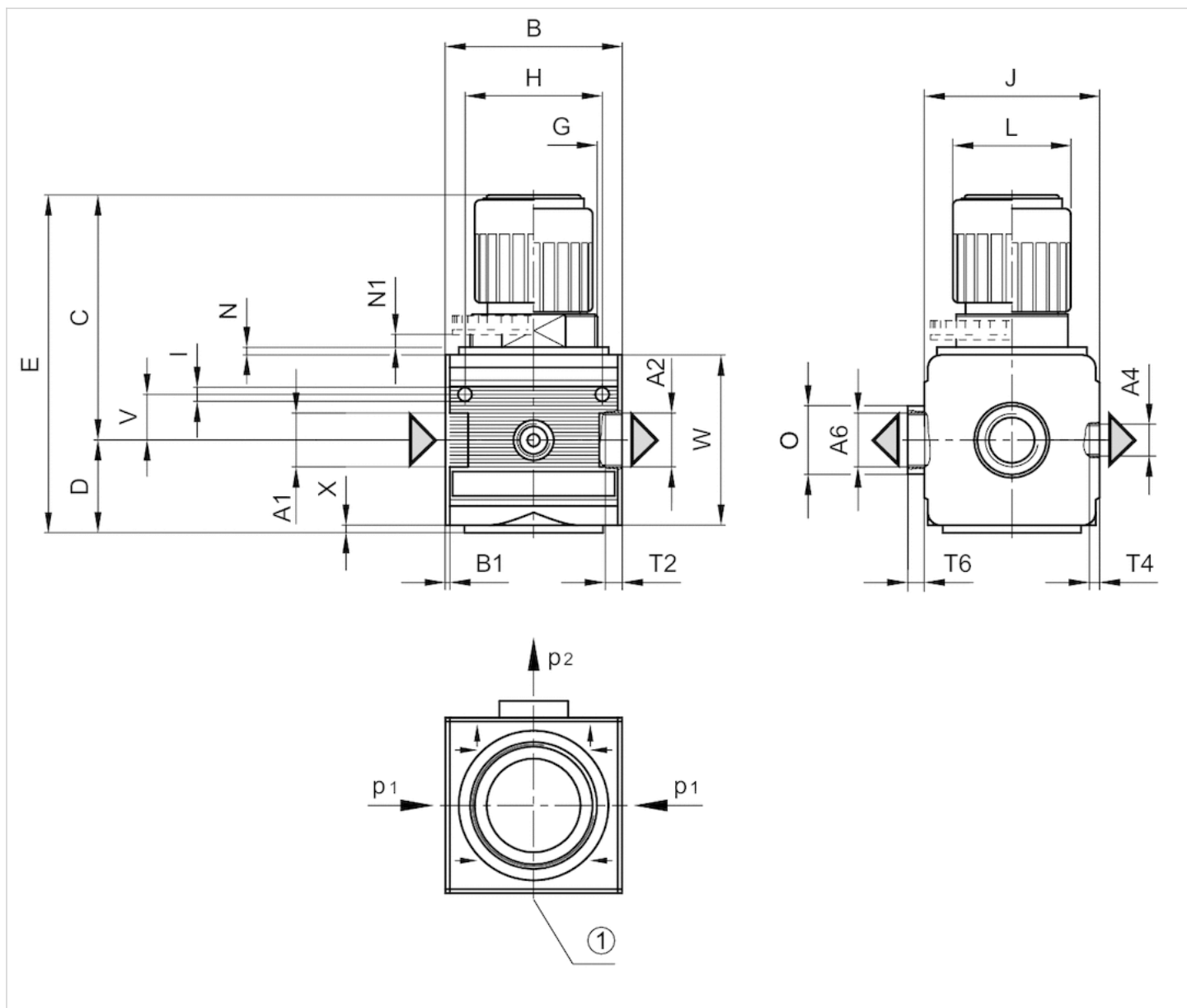

A1 = input A2 = output

A4 = output A6 = output

1) pressure gauge connection p1 = working pressure p2 = secondary pressure

### Dimensions in mm

A1	A2	A4	A6	B	B1	C	D	E	G	H	I	J	L	N	N1	O	T2	T4	T6	V	W	X
G 1/2	G 1/2	G 1/4	G 1/2	69.6	1.8	97	35.5	132.5	M50x1,5	54	5.5	69	46	3	5.5	27	13	7	6	18	67	2
G 1/2	G 1/2	G 1/4	G 1/2	69.6	1.8	97	35.5	132.5	M50x1,5	54	5.5	69	46	3	5.5	27	13	7	6	18	67	2

# Diagrams

## Application example

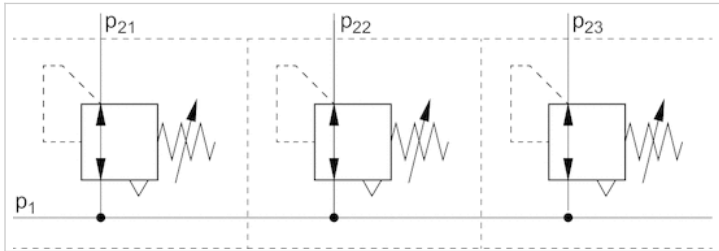

$p_1$  = working pressure  
 $p_{21}$ ;  $p_{22}$ ;  $p_{23}$  = secondary pressure

## Pressure characteristics curve

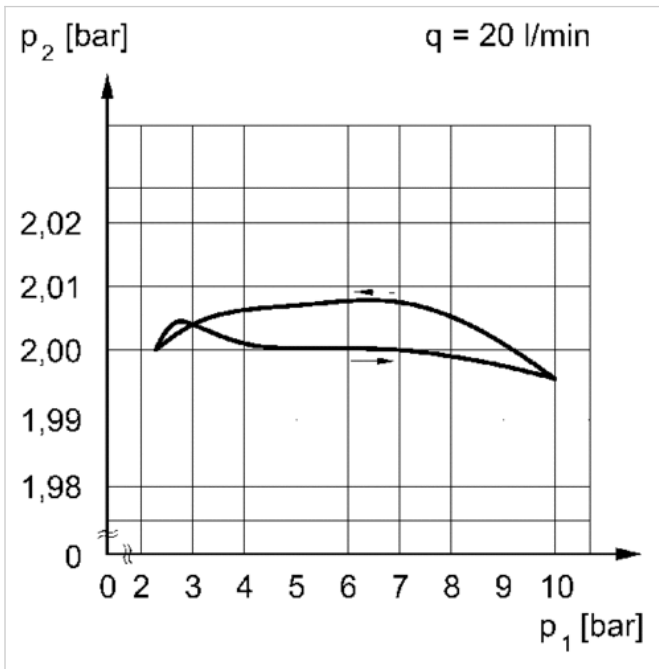

$p_1$  = working pressure  $p_2$  = secondary pressure  $q$  = flow rate

Flow rate characteristic

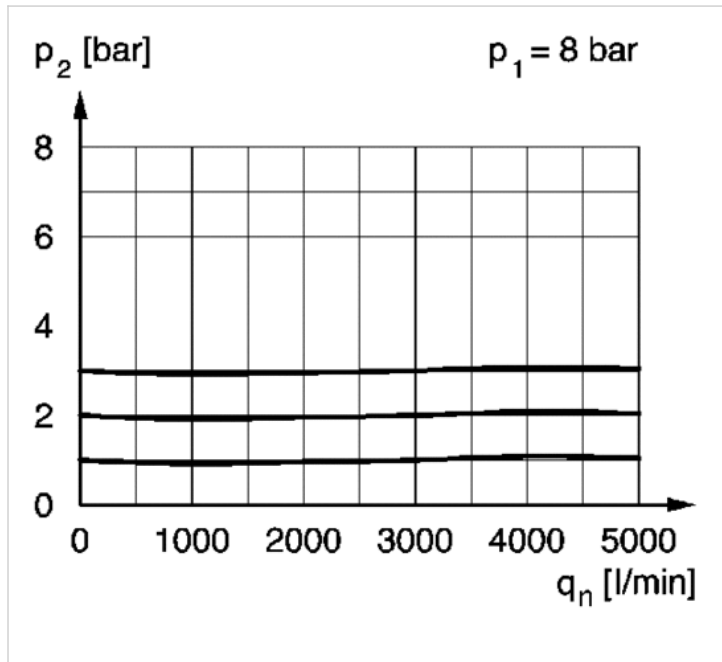

p2 = 0,1 - 3 bar  
p1 = Working pressure p2 = Secondary pressure qn = Nominal flow

Flow rate characteristic

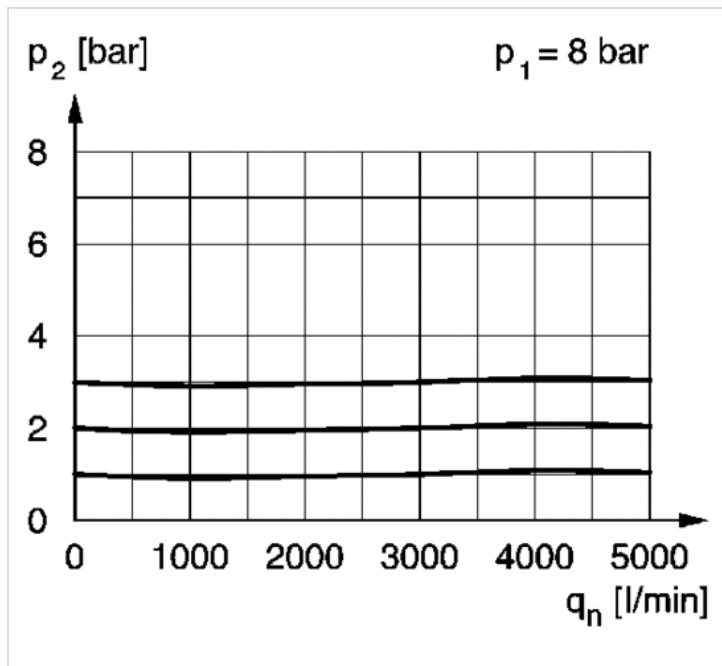

p2 = 0,2 - 6 bar  
p1 = Working pressure p2 = Secondary pressure qn = Nominal flow

Flow rate characteristic

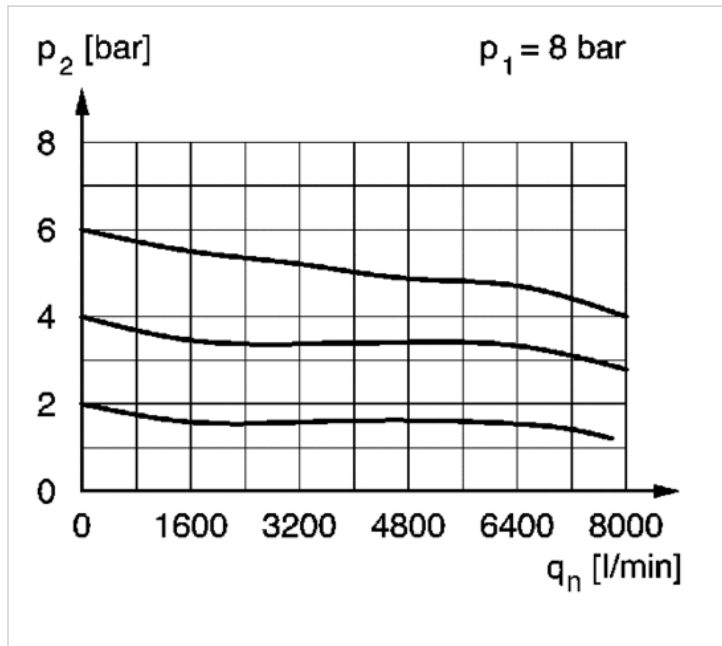

$p_2 = 0,5 - 10$  bar

$p_1 =$  Working pressure  $p_2 =$  Secondary pressure  $q_n =$  Nominal flow