











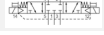

# 5/3-directional valve, Series TC08

- Operating voltage 24 V DC
- Qn = 700 l/min
- Pilot valve width : 15 mm
- Pipe connection
- Compressed air connection output : G 1/8
- Electrical connection : Plug, M8, 4-pin
- Manual override : without detent
- Double solenoid
- Pilot : internal external

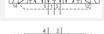

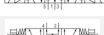
Version	Spool valve, positive overlapping
Activation	Electrically
Sealing principle	Soft sealing
Working pressure min./max.	See table below
Control pressure min./max.	3 ... 10 bar
Ambient temperature min./max.	-10 ... 50 °C
Medium temperature min./max.	-10 ... 50 °C
Medium	Compressed air
Max. particle size	5 µm
Oil content of compressed air	0 ... 5 mg/m <sup>3</sup>
Nominal flow Qn	700 l/min
Connector standard	DIN EN 60947-5-2
Protection class acc. to DIN EN 61140	Class III
Electrically	
Protection class with connection	IP65
LED status display	Yellow
Duty cycle	100 %
Typ. switch-on time	10 ms
Typ. switch-off time	11 ms
Mounting on manifold strip	P-strip
Mounting screw tightening torque	2 Nm
Weight	0,178 kg

## Technical data

Part No.		MO	Compressed air connection	
			Input	Output
0820061301			G 1/8	G 1/8
0820061351			G 1/8	G 1/8
0820061311			G 1/8	G 1/8
0820061361			G 1/8	G 1/8
0820061321			G 1/8	G 1/8
0820061371			G 1/8	G 1/8

Part No.	Compressed air connection	Operational voltage	Voltage tolerance
	Exhaust	DC	DC
0820061301	G 1/8	24 V	-10% / +10%
0820061351	G 1/8	24 V	-10% / +10%
0820061311	G 1/8	24 V	-10% / +10%
0820061361	G 1/8	24 V	-10% / +10%
0820061321	G 1/8	24 V	-10% / +10%
0820061371	G 1/8	24 V	-10% / +10%

Part No.	Power consumption	Pilot	Flow conductance	Flow conductance	Nominal resistance
	DC		b	C-value	
0820061301	2,2 W	internal	0,34	3 l/(s*bar)	280 Ω
0820061351	2,2 W	external	0,34	3 l/(s*bar)	280 Ω
0820061311	2,2 W	internal	0,34	3 l/(s*bar)	280 Ω
0820061361	2,2 W	external	0,34	3 l/(s*bar)	280 Ω
0820061321	2,2 W	internal	0,34	3 l/(s*bar)	280 Ω
0820061371	2,2 W	external	0,34	3 l/(s*bar)	280 Ω

Part No.	Working pressure min./max.
0820061301	3 ... 10 bar
0820061351	-0,9 ... 10 bar
0820061311	3 ... 10 bar
0820061361	-0,9 ... 10 bar
0820061321	3 ... 10 bar
0820061371	-0,9 ... 10 bar

Nominal flow Q<sub>n</sub> at 6 bar and Δp = 1 bar, MO = Manual override

## Technical information

The min. control pressure must be adhered to, since otherwise faulty switching and valve failure may result!

The pressure dew point must be at least 15 °C under ambient and medium temperature and may not exceed 3 °C .

The oil content of compressed air must remain constant during the life cycle.

Use only the approved oils from AVENTICS. Further information can be found in the "Technical information" document (available in the MediaCentre).

## Technical information

Material	
Housing	Polyamide, fiber-glass reinforced
Seals	Acrylonitrile butadiene rubber Polyurethane
Front plate	Polyamide, fiber-glass reinforced
Threaded bushing	Brass Die cast zinc, nickel-plated chrome-plated

## Dimensions

### Dimensions

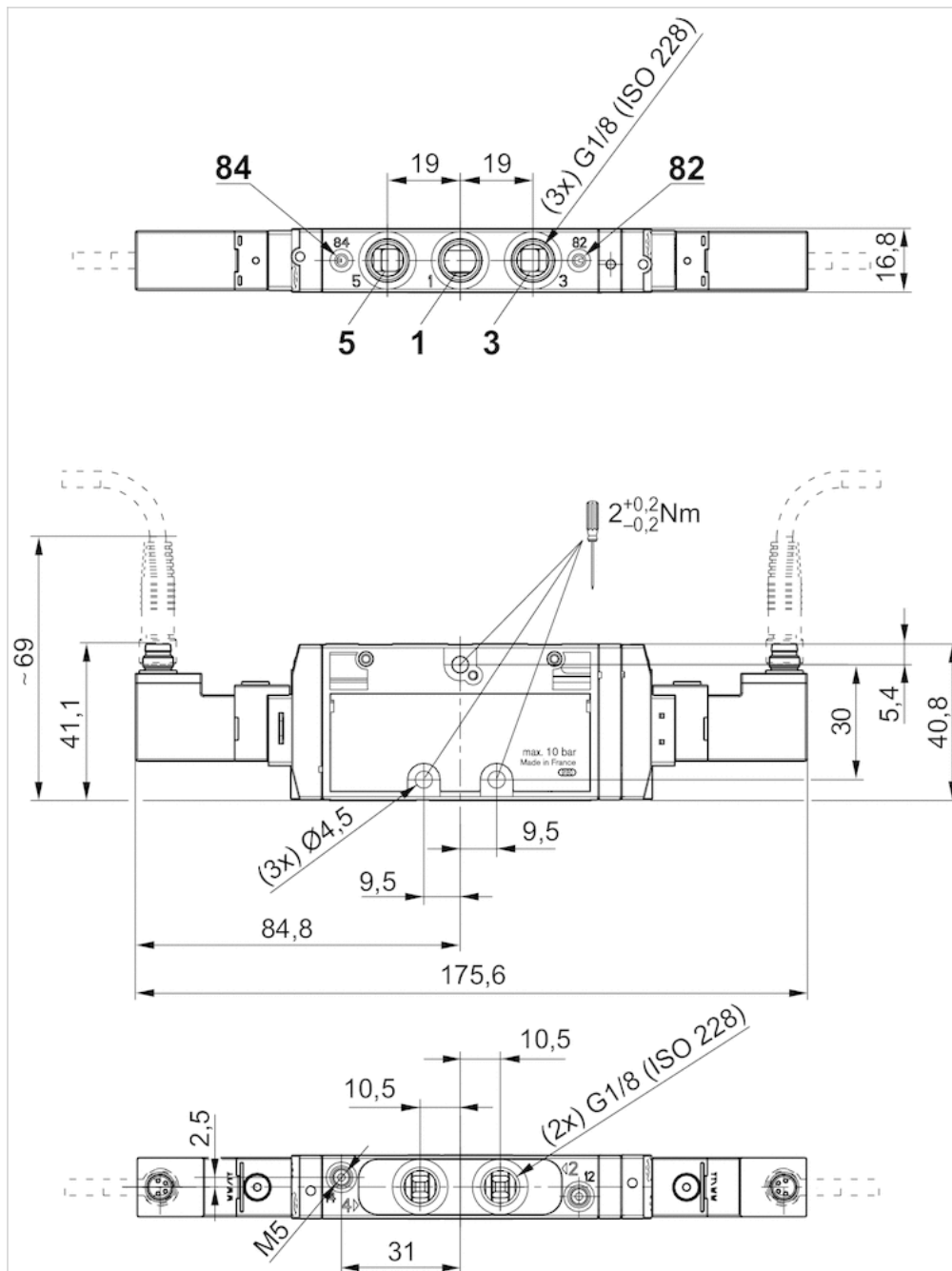

## Pin assignments

### PIN assignment and cable colors for valve plug connectors

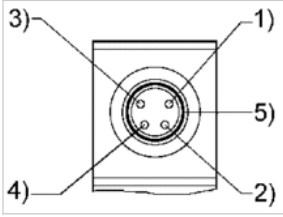

PIN assignment: 1) PIN not assigned 2) PIN not assigned 3) 0 V4) 24 V5) LED  
Cable colors 1) Brown 2) White 3) Blue 4) Black