

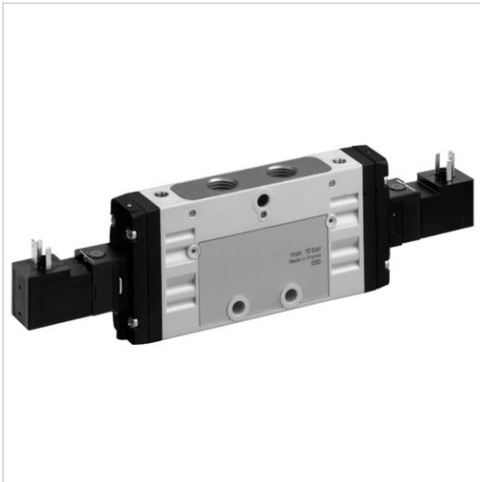













## 2x3/2-directional valve, Series TC15

- Operating voltage 24 V DC
- Qn = 1100 l/min
- Pilot valve width : 15 mm
- Pipe connection
- Compressed air connection output : G 1/4
- Electrical connection : Plug, ISO 15217, form C
- Manual override : without detent
- Double solenoid
- With spring return
- Pilot : external, internal



|  |                                   |
|--|-----------------------------------|
| Version                                      | Spool valve, positive overlapping |
| Activation                                   | Electrically                      |
| Pilot  | external, internal                |
| Sealing principle                            | Soft sealing                      |
| Working pressure min./max.                   | See table below                   |
| Control pressure min./max.                   | 3 ... 10 bar                      |
| Ambient temperature min./max.                | -10 ... 50 °C                     |
| Medium temperature min./max.                 | -10 ... 50 °C                     |
| Medium                                       | Compressed air                    |
| Max. particle size                           | 5 µm                              |
| Oil content of compressed air                | 0 ... 5 mg/m <sup>3</sup>         |
| Nominal flow Qn                              | 1100 l/min                        |
| Compressed air connection                    | according to ISO 228-1            |
| Connector standard                           | ISO 15217                         |
| Protection class with connection             | IP65                              |
| Duty cycle                                   | 100 %                             |
| Typ. switch-on time                          | 12 ms                             |
| Typ. switch-off time                         | 16 ms                             |
| Generic emission standard in accordance with | EN 50081-2:1993                   |
| Mounting on manifold strip                   | P-strip                           |
| Mounting screw tightening torque             | 2,5 Nm                            |
| Tightening torque tolerance                  | ±0,2 mT                           |
| Weight                                       | 0,278 kg                          |

## Technical data

| Part No.   |  | NC/NC | MO  | Compressed air connection |  |
|------------|---|-------|---|---------------------------|--|
|            |   |       |   | Input                     |  |
| R422102158 |  | NC/NC |  | G 1/4                     |  |
| R422102162 |  | NO/NO |  | G 1/4                     |  |
| R422102166 |  | NC/NO |  | G 1/4                     |  |
| R422102169 |  | NC/NC |  | G 1/4                     |  |
| R422102172 |  | NO/NO |  | G 1/4                     |  |
| R422102175 |  | NC/NO |  | G 1/4                     |  |

| Part No.   | Compressed air connection |         |
|------------|---------------------------|---------|
|            | Output                    | Exhaust |
| R422102158 | G 1/4                     | G 1/4   |
| R422102162 | G 1/4                     | G 1/4   |
| R422102166 | G 1/4                     | G 1/4   |
| R422102169 | G 1/4                     | G 1/4   |
| R422102172 | G 1/4                     | G 1/4   |
| R422102175 | G 1/4                     | G 1/4   |

| Part No.   | Compressed air connection |  | Operational voltage |                   |
|------------|---------------------------|--|---------------------|-------------------|
|            | Pilot Input               |  | DC                  | Voltage tolerance |
| R422102158 | -                         |  | 24 V                | -10% / +10%       |
| R422102162 | -                         |  | 24 V                | -10% / +10%       |
| R422102166 | -                         |  | 24 V                | -10% / +10%       |
| R422102169 | M5                        |  | 24 V                | -10% / +10%       |
| R422102172 | M5                        |  | 24 V                | -10% / +10%       |
| R422102175 | M5                        |  | 24 V                | -10% / +10%       |

| Part No.   | Power consumption |  | Flow conductance |               | Nominal resistance |
|------------|-------------------|--|------------------|---------------|--------------------|
|            | DC                |  | b                | C-value       |                    |
| R422102158 | 2 W               |  | 0,25             | 5,9 l/(s*bar) | 280 Ω              |
| R422102162 | 2 W               |  | 0,25             | 5,9 l/(s*bar) | 280 Ω              |
| R422102166 | 2 W               |  | 0,25             | 5,9 l/(s*bar) | 280 Ω              |
| R422102169 | 2 W               |  | 0,25             | 5,9 l/(s*bar) | 280 Ω              |
| R422102172 | 2 W               |  | 0,25             | 5,9 l/(s*bar) | 280 Ω              |
| R422102175 | 2 W               |  | 0,25             | 5,9 l/(s*bar) | 280 Ω              |

| Part No.   | Working pressure min./max. |
|------------|----------------------------|
| R422102158 | 3 ... 10 bar               |
| R422102162 | 3 ... 10 bar               |
| R422102166 | 3 ... 10 bar               |
| R422102169 | -0,9 ... 10 bar            |
| R422102172 | -0,9 ... 10 bar            |
| R422102175 | -0,9 ... 10 bar            |

Nominal flow Qn at 6 bar and  $\Delta p = 1$  bar, MO = Manual override

## Technical information

The min. control pressure must be adhered to, since otherwise faulty switching and valve failure may result!

The pressure dew point must be at least 15 °C under ambient and medium temperature and may not exceed 3 °C .

The oil content of compressed air must remain constant during the life cycle.

Use only the approved oils from AVENTICS. Further information can be found in the "Technical information" document (available in the MediaCentre).

## Technical information

| Material         |  |
|------------------|--|
| Housing          | Polyamide, fiber-glass reinforced                                    |
| Seals            | Acrylonitrile butadiene rubber Hydrogenated nitrile butadiene rubber |
| Front plate      | Polyamide, fiber-glass reinforced                                    |
| Threaded bushing | Brass Die cast zinc, nickel-plated chrome-plated                     |

# Dimensions

## Dimensions

