

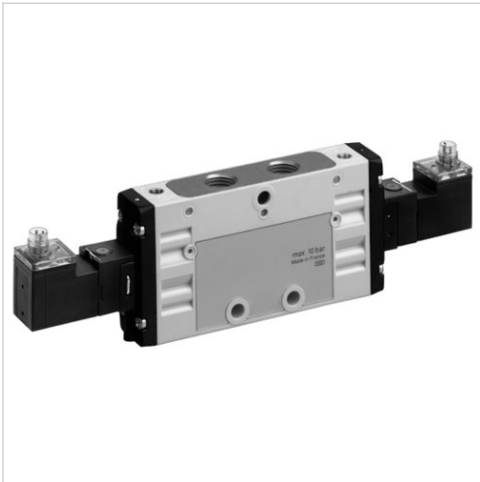











2x3/2-directional valve, Series TC15

- Operating voltage 24 V DC
- Qn = 1100 l/min
- Pilot valve width : 15 mm
- Pipe connection
- Compressed air connection output : G 1/4
- Electrical connection : Plug, M8, 4-pin
- Manual override : without detent
- Double solenoid
- With spring return
- Pilot : external, internal



Version	Spool valve, positive overlapping
Activation	Electrically
Pilot	external, internal
Sealing principle	Soft sealing
Working pressure min./max.	See table below
Control pressure min./max.	3 ... 10 bar
Ambient temperature min./max.	-10 ... 50 °C
Medium temperature min./max.	-10 ... 50 °C
Medium	Compressed air
Max. particle size	5 µm
Oil content of compressed air	0 ... 5 mg/m ³
Nominal flow Qn	1100 l/min
Compressed air connection	according to ISO 228-1
Connector standard	DIN EN 60947-5-2
Protection class acc. to DIN EN 61140	Class III
Electrically	
Protection class with connection	IP65
LED status display	Yellow
Duty cycle	100 %
Typ. switch-on time	12 ms
Typ. switch-off time	16 ms
Generic immunity standard in accordance EN 50082-2 with	
Mounting on manifold strip	P-strip
Mounting screw tightening torque	2,5 Nm
Tightening torque tolerance	±0,2 mT
Weight	0,279 kg

Technical data

Part No.			MO	Compressed air connection	
				Input	
R422102184		NC/NC		G 1/4	
R422102185		NO/NO		G 1/4	
R422102186		NC/NO		G 1/4	
R422102187		NC/NC		G 1/4	
R422102188		NO/NO		G 1/4	
R422102189		NC/NO		G 1/4	

Part No.	Compressed air connection	
	Output	Exhaust
R422102184	G 1/4	G 1/4
R422102185	G 1/4	G 1/4
R422102186	G 1/4	G 1/4
R422102187	G 1/4	G 1/4
R422102188	G 1/4	G 1/4
R422102189	G 1/4	G 1/4

Part No.	Compressed air connection		Operational voltage	
	Pilot Input		DC	DC
R422102184	-		24 V	-10% / +10%
R422102185	-		24 V	-10% / +10%
R422102186	-		24 V	-10% / +10%
R422102187	M5		24 V	-10% / +10%
R422102188	M5		24 V	-10% / +10%
R422102189	M5		24 V	-10% / +10%

Part No.	Power consumption		Flow conductance		Nominal resistance
	DC		b	C-value	
R422102184	2,2 W		0,25	5,9 l/(s*bar)	280 Ω
R422102185	2,2 W		0,25	5,9 l/(s*bar)	280 Ω
R422102186	2,2 W		0,25	5,9 l/(s*bar)	280 Ω
R422102187	2,2 W		0,25	5,9 l/(s*bar)	280 Ω
R422102188	2,2 W		0,25	5,9 l/(s*bar)	280 Ω
R422102189	2,2 W		0,25	5,9 l/(s*bar)	280 Ω

Part No.	Working pressure min./max.
R422102184	3 ... 10 bar
R422102185	3 ... 10 bar
R422102186	3 ... 10 bar
R422102187	-0,9 ... 10 bar
R422102188	-0,9 ... 10 bar
R422102189	-0,9 ... 10 bar

Nominal flow Qn at 6 bar and $\Delta p = 1$ bar, MO = Manual override

Technical information

The min. control pressure must be adhered to, since otherwise faulty switching and valve failure may result!

The pressure dew point must be at least 15 °C under ambient and medium temperature and may not exceed 3 °C .

The oil content of compressed air must remain constant during the life cycle.

Use only the approved oils from AVENTICS. Further information can be found in the "Technical information" document (available in the MediaCentre).

Technical information

Material	
Housing	Polyamide, fiber-glass reinforced
Seals	Acrylonitrile butadiene rubber Hydrogenated nitrile butadiene rubber
Front plate	Polyamide, fiber-glass reinforced
Threaded bushing	Brass Die cast zinc, nickel-plated chrome-plated

Dimensions

Dimensions

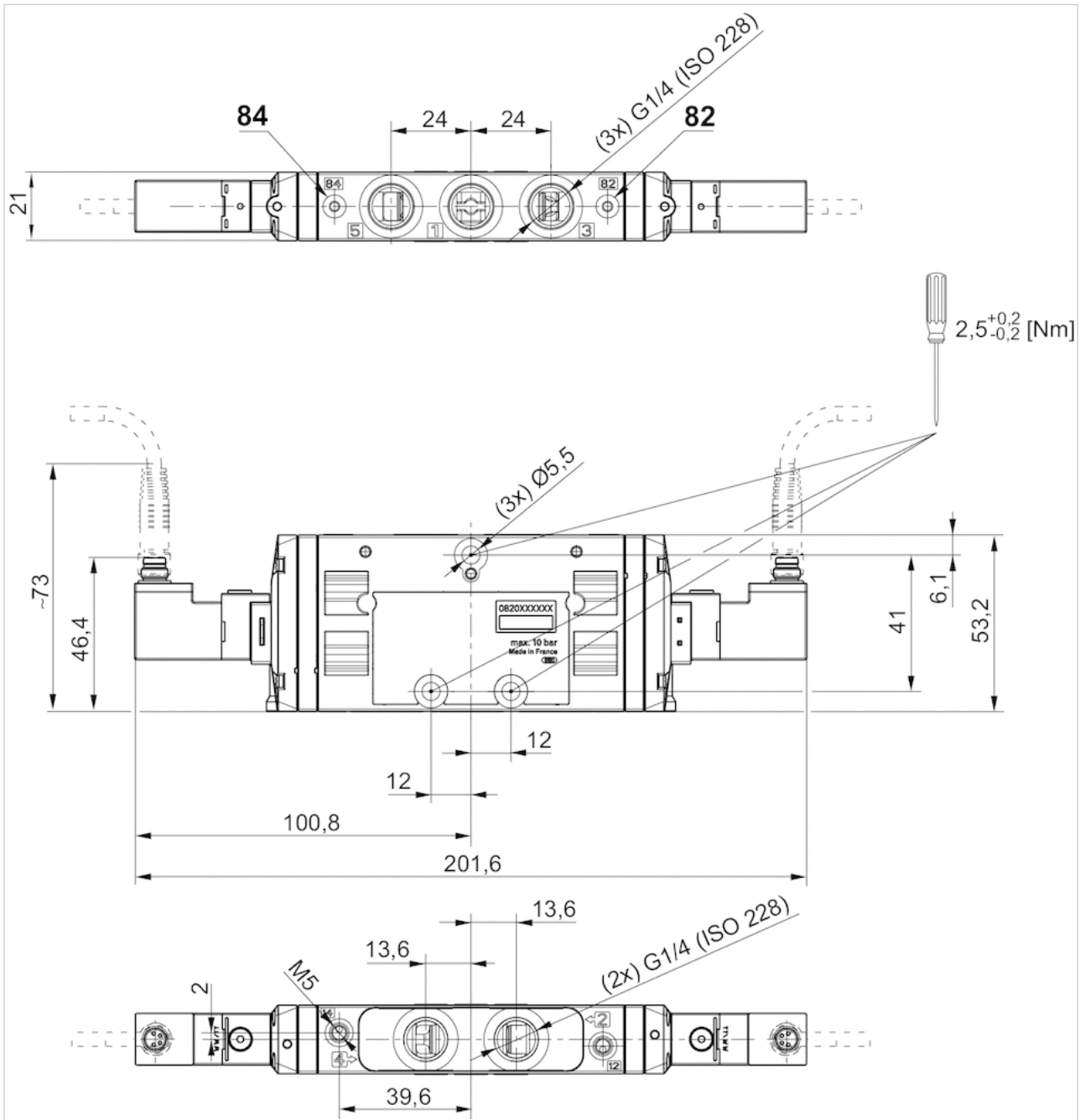

Pin assignments

PIN assignment and cable colors for valve plug connectors

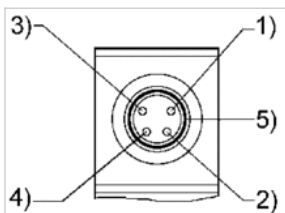

PIN assignment: 1) PIN not assigned 2) PIN not assigned 3) 0 V4) 24 V5) LED Cable colors 1) Brown 2) White 3) Blue 4) Black

UK Office
5 Caulside Drive
Antrim
BT41 2DU
United Kingdom
+44 (0) 28 9448 1808

European Office
Unit 6, Saint Anthony's Business Park
Dublin
D22 VW95
Ireland
+353 (0) 1 4373653

